

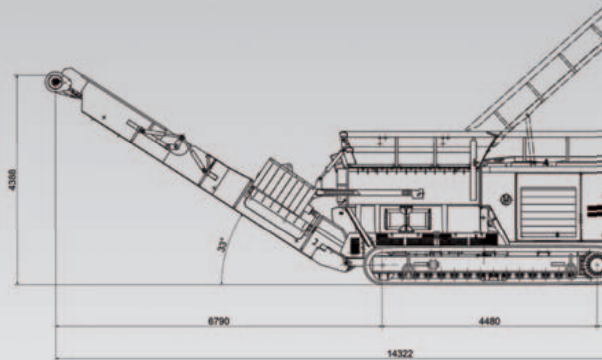

HAMMEL[®]
RECYCLINGTECHNIK

Primary Shredder *Diesel / Electric*

Type 450 / 650 / 750 / 850 / 950 / 1500





“We prove power“ – HAMMEL-primary shredder

The HAMMEL-primary shredder is versatile in the shredding of materials, such as waste wood, root stems, green waste, bulky, commercial and domestic waste as well as in the processing of car bodies, tires, aluminum profiles and light metals. Due to its robust and clear design, the HAMMEL-shredder is a reliable working tool.

It is equipped with two slow-moving, interlocking tool shafts that rotate at a maximum speed of 43 rpm.

ADVANTAGES

- high throughput
- user-friendly handling
- minimal dust generation
- long service life of shredding tools
- low wear and tear
- very low noise
- customizable
- low consumption
- short set-up times
- economical operation





The innovative “2-shaft principle“

Each HAMMEL-primary shredder operates with the innovative "2-shaft principle". The shafts with their interlocking hooks and knives pull in the material directly and shred it efficiently. When the hydraulic final pressure is reached during the shredding process the shafts reverse automatically.

Depending on the input material and the requirements of the end product, special shaft configurations exist. Generally, end product sizes between approx. 80 mm and 400 mm are possible, with a small amount of larger fractions.

ADVANTAGES

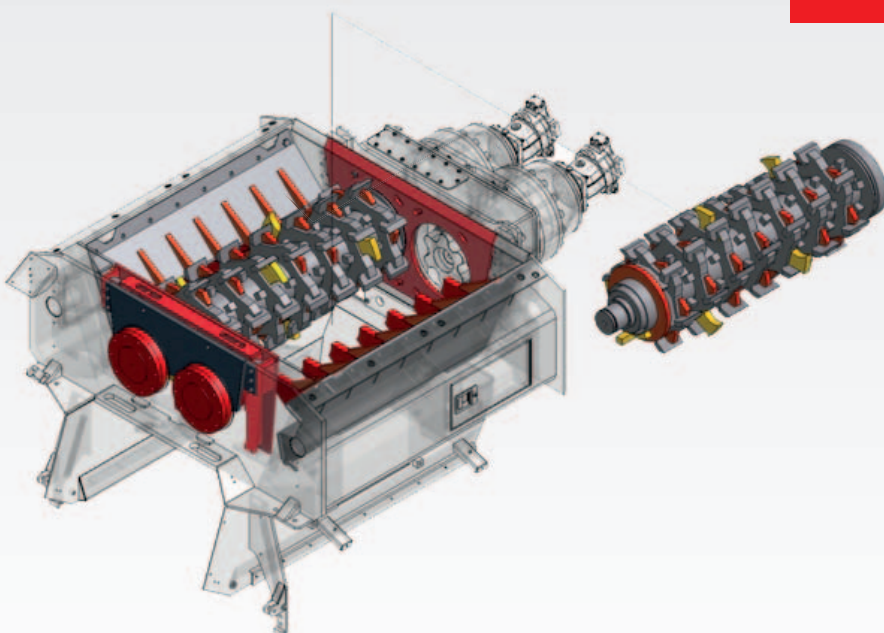

- exceptionally good intake behavior
- no pressure backup required
- automatic reverse function
- self-cleaning
- wrapping of wires and long-fiber materials is avoided
- depending on the material, long service life of several thousand hours of operation

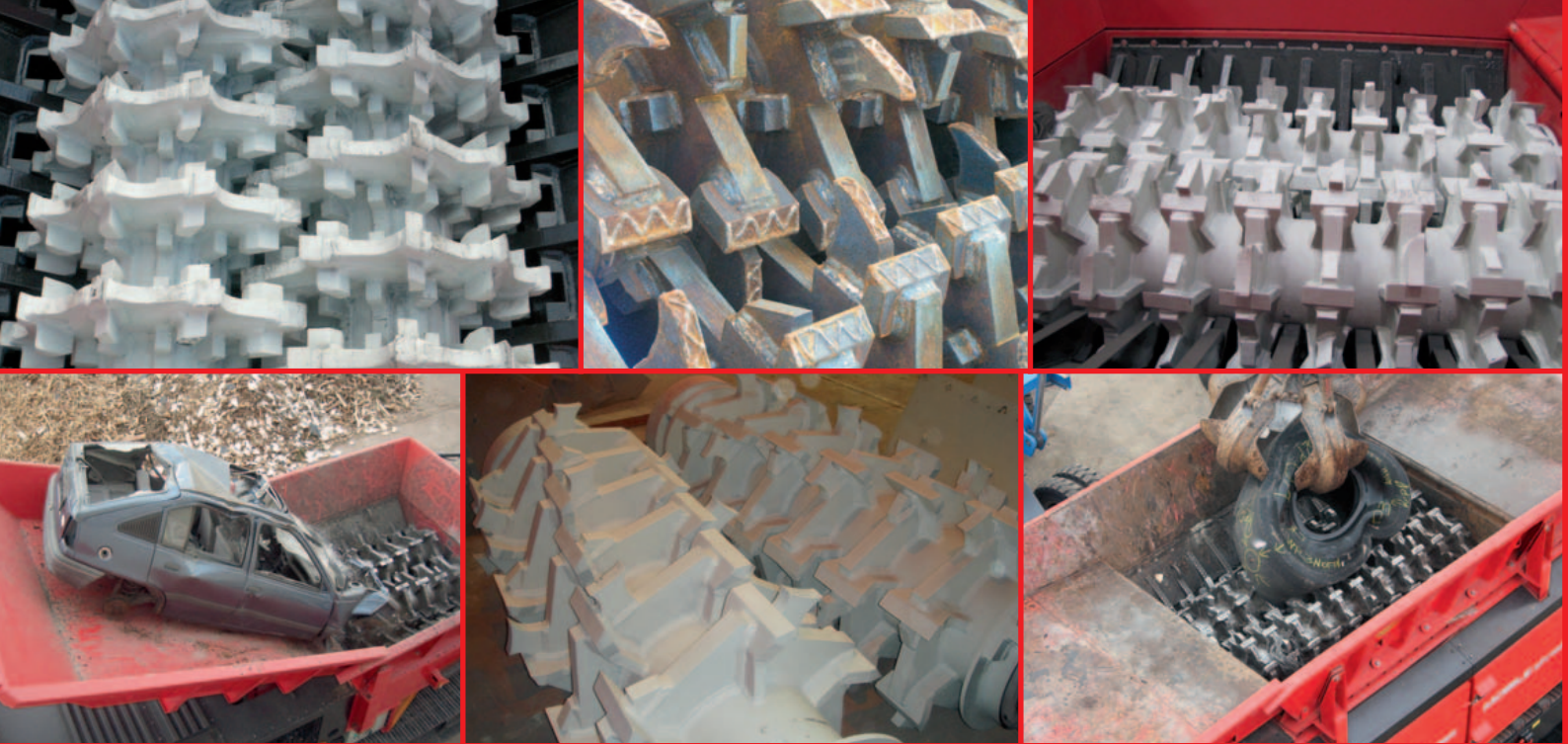

The right shafts for each material

Varying shredding tasks require specific shafts. The many variations of shredding shafts make it possible to respond to individual customer requirements. The proven "2-shaft-principle" is constantly evolving and is adapted to the relevant market and customer needs.

WOOD SHAFTS

option 1

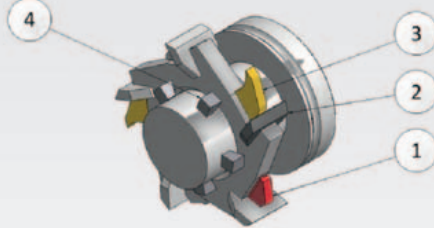

- 1 blunt forward hook
- 2 knife
- 3 forward hook
- 4 blocks

fig. 5-knives with blocks

option 2

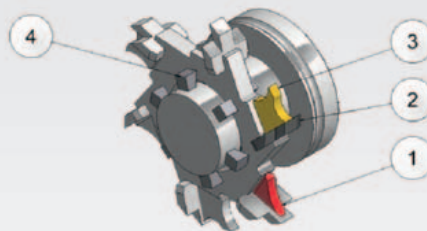

- 1 blunt forward hook
- 2 knife
- 3 forward hook
- 4 blocks

fig. 6-knives with blocks

WASTE SHAFTS

option 1

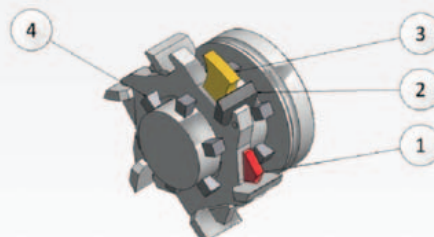

- 1 blunt forward hook
- 2 knife
- 3 combination forward / backward hook
- 4 retainers

fig. 6-knives with blocks

option 2

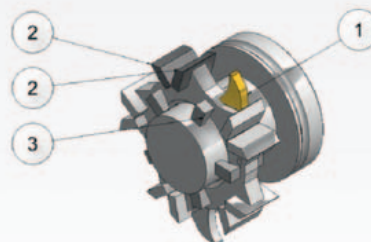

- 1 hook
- 2 knife (V-shaped)
- 3 blocks

fig. 5-knives with blocks, forward-backward





METAL SHAFTS

metal

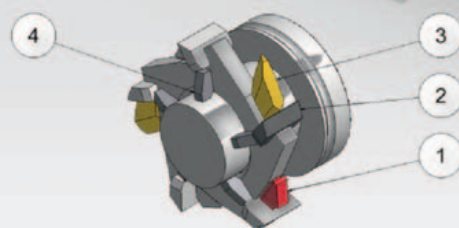

- 1 blunt forward hook
- 2 knife
- 3 forward hook
- 4 retainer

fig. 5-knives with retainers

SPECIAL SHAFTS

stones and soils

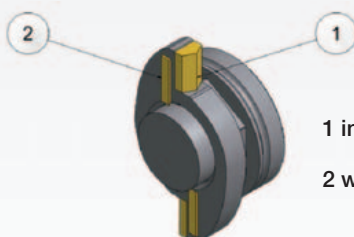

- 1 impact plate
- 2 wear protection

railway sleepers

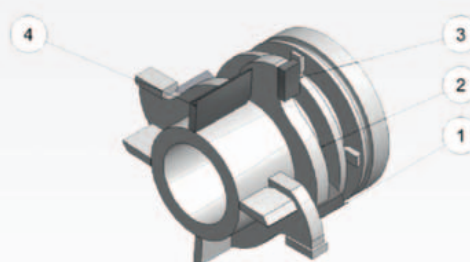

- 1 cutting plate, small
- 2 tool holder
- 3 impact plate
- 4 cutting plate, large



Everything began with the shredding of wood!

In 1984 the first HAMMEL-primary shredder for the processing of root stems was developed. Up to date, the wood recycling market has challenged us and the HAMMEL-shredding technology has always met the needs of the time.

Benefiting from the years of experience are our customers, as tools are individually adapted to the respective requirements and special tasks. Because of the right tools enormous cost efficiency with very low wear, low energy consumption and high performance is achieved.

APPLICATION

- waste wood
- demolition wood
- stem wood
- root stems
- green waste
- railway sleepers
- pallets
- cable drums





Performance data*

material	450	650	750	850	950	1500
waste wood	12 t/h	30 t/h	60 t/h	120 t/h	230 t/h	300 t/h
pallets	10 t/h	25 t/h	50 t/h	90 t/h	200 t/h	250 t/h
cable drums	6 t/h	20 t/h	40 t/h	60 t/h	130 t/h	150 t/h
railway sleepers	x	15 t/h	25 t/h	50 t/h	70 t/h	100 t/h
root stems	8 t/h	20 t/h	35 t/h	55 t/h	90 t/h	130 t/h
green waste	6 t/h	15 t/h	30 t/h	50 t/h	80 t/h	120 t/h

* The given performance data are approximates, without guarantee and depending on the corresponding features of the primary shredder, the shaft configuration and the optimal material supply.

x Primary shredder is not suitable for processing this material.



Contact us before you drown in waste!

At the beginning of the 90´ s the HAMMEL-shredder has been adapted to the demands of the waste processing industry and since then has been successfully established as a market-leading product for the shredding of various types of waste.

With versatile tool configurations, it is possible that various input materials are pre-shredded to the desired product end size. Our HAMMEL-shredders are used in incineration plants, in the processing of alternative fuels, as pre-shredders in sorting lines or for volume reduction. Due to the "two-shaft principle" the material is pre-shredded to a homogeneous end product and optimally prepared for further use.

APPLICATION

- domestic waste
- industrial & commercial waste
- bulky waste
- C & D
- paper
- paper rolls
- tires





Performance data*

material	450	650	750	850	950	1500
domestic waste	10 t/h	20 t/h	50 t/h	100 t/h	200 t/h	250 t/h
industrial waste	8 t/h	15 t/h	45 t/h	80 t/h	150 t/h	200 t/h
bulky waste	8 t/h	15 t/h	30 t/h	50 t/h	110 t/h	160 t/h
C & D	8 t/h	15 t/h	35 t/h	80 t/h	150 t/h	200 t/h
paper	5 t/h	10 t/h	20 t/h	45 t/h	70 t/h	120 t/h
paper rolls	5 t/h	8 t/h	15 t/h	30 t/h	60 t/h	100 t/h
tires	5 t/h	8 t/h	20 t/h	30 t/h	50 t/h	80 t/h

* The given performance data are approximates, without guarantee and depending on the corresponding features of the primary shredder, the shaft configuration and the optimal material supply.



At the forefront of metals recycling

For several years now HAMMEL Recyclingtechnik GmbH also deals with the issue of metal shredding and scrap processing. In this field we have been able to establish ourselves successfully and especially with the HAMMEL-primary shredders VB 950 DK "RED GIANT" and VB 1500 DK it is possible to efficiently shred large-volume scrap metal and car bodies.

For shredding metal, previous shafts have been optimized and adapted to the conditions of the material. Thus, with the help of these special metal shafts it is possible to achieve an optimum end product.

APPLICATION

- aluminum (profiles and bales)
- light mixed scrap
- car bodies
- white goods
- motor blocks
- electronic waste
- aircraft wrecks





Performance data*

material	450	650	750	850	950	1500
aluminum	5 t/h	8 t/h	12 t/h	20 t/h	40 t/h	80 t/h
light mixed scrap	x	7 t/h	10 t/h	18 t/h	25 t/h	50 t/h
car bodies	x	x	x	10 t/h	25 t/h	50 t/h
white goods	x	7 t/h	10 t/h	20 t/h	35 t/h	70 t/h
motor blocks	x	x	5 t/h	10 t/h	15 t/h	30 t/h

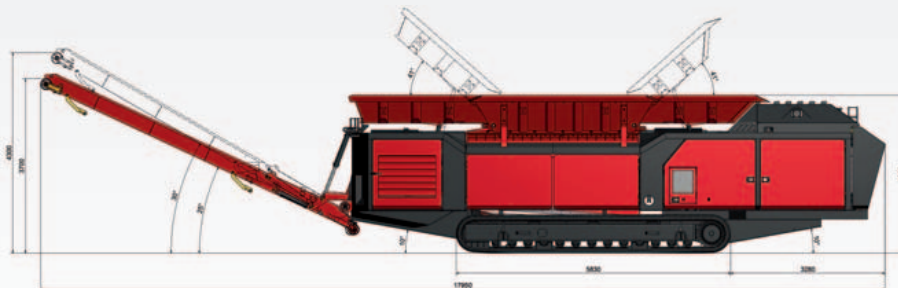

* The given performance data are approximates, without guarantee and depending on the corresponding features of the primary shredder, the shaft configuration and the optimal material supply.

x Primary shredder is not suitable for processing this material.

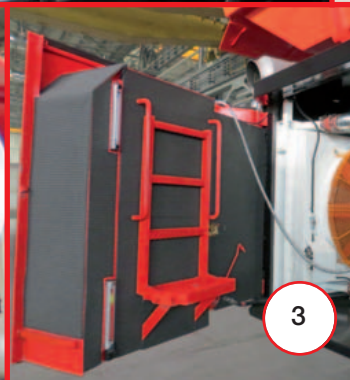
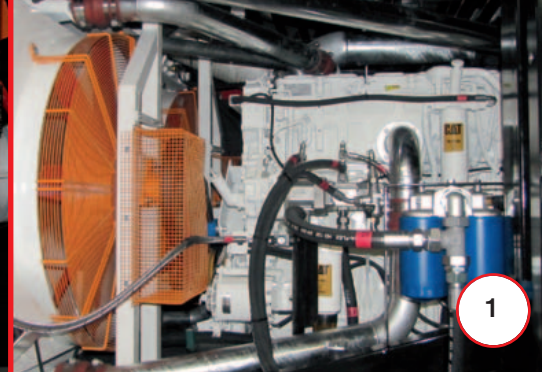

All inclusive

Each HAMMEL-primary shredder has an attractive basic configuration which conforms to the latest technical standards and ensures high quality. Thus, the shredder can meet the individual customer requirements.

BASIC CONFIGURATION

- 1. drive**
electric or diesel engine
- 2. transport capability**
semi-mobile on hook lift frame
- 3. sound emission**
specially developed exhaust system,
inside door trim with special insulation material
- 4. remote control**
with different functions
- 5. tilting hopper**
for optimum material feed





Additional equipment

For best results, each HAMMEL-primary shredder is tailored to the individual needs and thus obtains the right equipment. Furthermore, company HAMMEL offers a variety of options to achieve the best possible result in throughput and product end size for each customer.

1. **metal separation**
via a permanent-over-belt magnet
ferrous metal parts are separated
2. **hopper extension**
allows for increased capacity, prevents falling out of the input material
3. **track system**
mobile on track system, optional with track pads
4. **pulling drawbar**
enables a rapid relocation of the shredder on site
5. **breaker bar**
produces a smaller end product

6. **water sprinkling system**
reduces dust generation
7. **return ventilator**
efficient for cooling and cleaning
8. **special belt construction**
custom discharge conveyors for electric version
9. **winter package**
diesel and hydraulic oil preheating
10. **special paint**
to match your company colors
11. **PLC-control**
in the electric version

OPTIONS

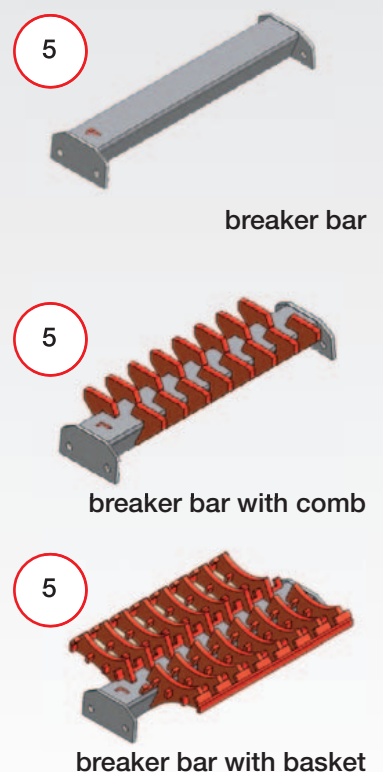

VB 450 VB 650 VB 750

Fields of application*

waste & mixed wood
green waste
pallets
light domestic/bulky waste

waste & mixed wood
green waste & root stems
domestic/bulky waste
aluminum

waste & mixed wood
green waste & root stems
domestic/industrial/bulky waste
aluminum & white goods

Version D – on stable frame with hook lift

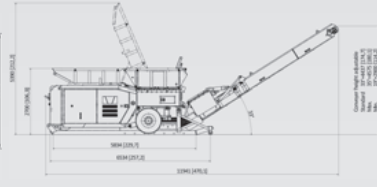
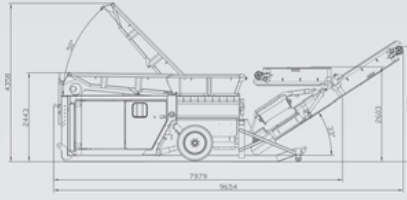
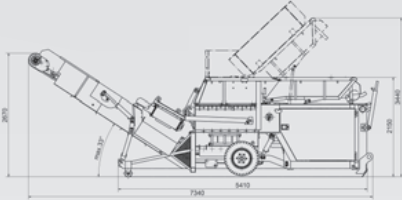

Technical data**

drive	140 hp	275 hp	350 hp
discharge height	2,7 at 33°	3,2 at 33°	4,4 at 33°
weight	8 t	16 t	18 t
fuel capacity	180 l	500 l	470 l
working dims. L/W/H	7,3 / 1,9 / 3,4	9,7 / 2,4 / 4,4	12,0 / 2,5 / 5,4
transp. dims. L/W/H	6,1 / 1,9 / 2,3	8,0 / 2,4 / 2,6	8,0 / 2,5 / 2,7

Version DK – mobile on track system

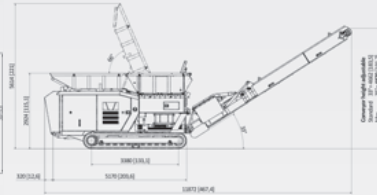
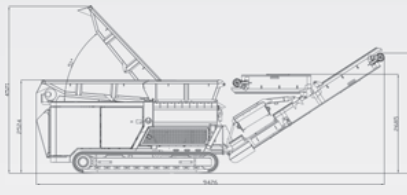
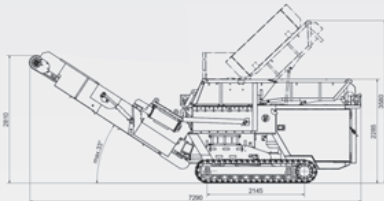

Technical data**

drive	140 hp	275 hp	350 hp
discharge height	2,8 at 33°	3,3 at 33°	4,7 at 33°
weight	11 t	17 t	19 t
fuel capacity	160 l	500 l	470 l
working dims. L/W/H	7,3 / 1,7 / 3,6	9,4 / 2,5 / 4,5	11,9 / 2,5 / 5,6
transp. dims. L/W/H	5,9 / 1,7 / 2,4	7,7 / 2,5 / 2,7	8,0 / 2,5 / 2,9

Version E – stationary on stable frame

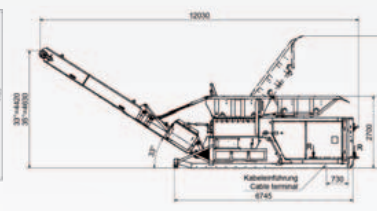
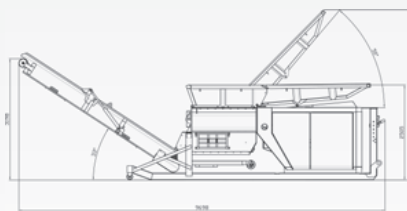
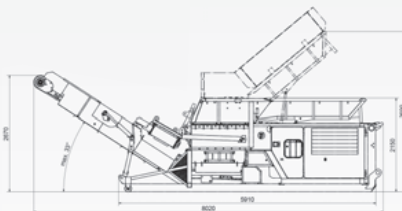

Technical data**

drive	110 kW	2 x 90 kW	2 x 132 kW
discharge height	2,7 at 33°	3,2 at 33°	4,4 at 33°
weight	8 t	16 t	20 t
working dims. L/W/H	8,0 / 1,9 / 3,7	9,5 / 2,4 / 4,5	12,0 / 2,5 / 5,0

* excerpt of the possible areas of application

** approx. values, depending on equipment, without guarantee, all dimensions in meters, drawings show optional equipment

VB 850

VB 950

VB 1500

waste & mixed wood
green waste & root stems
domestic/industrial/bulky waste
aluminum & white goods

waste & mixed wood
domestic/industrial/bulky waste
aluminum profiles & light mixed scrap
car bodies

car bodies
light mixed scrap
white goods
aluminum (profiles and bales)

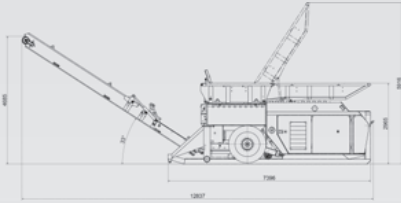

480 hp
4,7 at 33°
27 t
680 l
12,8 / 2,5 / 6,0
8,9 / 2,5 / 3,0

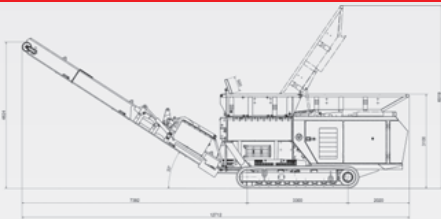

480 hp
4,8 at 33°
34 t
680 l
12,8 / 2,6 / 6,0
8,6 / 2,6 / 3,2

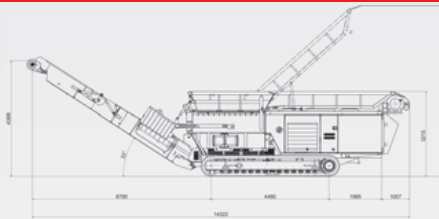

710 hp
4,4 at 33°
43 t
1.260 l
14,6 / 3,0 / 6,5
12,6 / 3,0 / 3,2

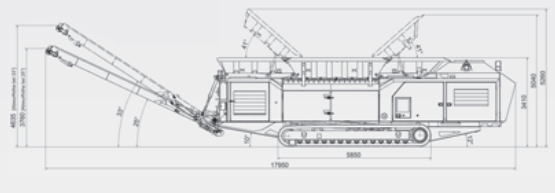

1.530 hp
4,6 at 33°
60 t
1.500 l
18,0 / 3,3 / 5,3
12,1 / 3,3 / 3,4

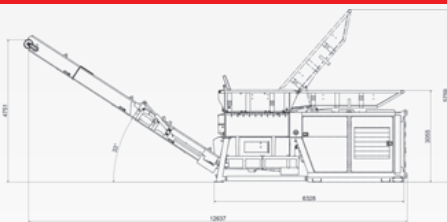

2 x 160 kW
4,8 at 33°
25 t
12,6 / 2,8 / 5,8

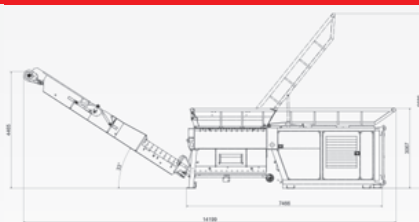

2 x 250 kW
4,5 at 33°
36 t
14,2 / 3,0 / 6,7

**COMING
SOON!**

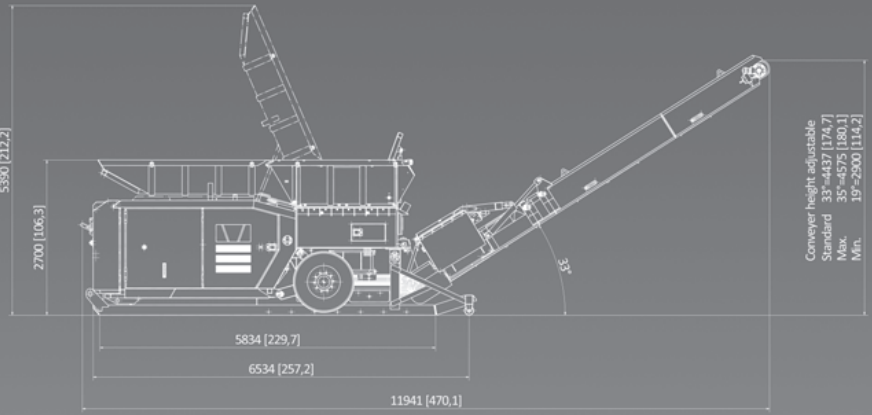

HAMMEL central in Europe



HAMMEL

Recyclingtechnik GmbH

Leimbacher Straße 103
D-36433 Bad Salzungen

Phone: +49 (0) 36 95 / 69 91-0
Fax: +49 (0) 36 95 / 69 91-93
Internet: www.hammel.de
E-Mail: info@hammel.de



No responsibility is taken for the correctness of this information.